

Model 41027, 41027T

➤ *Owner's/Installation Guide*

AUTO COMMAND

Professional Series

limited lifetime consumer warranty

Directed Electronics (hereinafter "Directed") promises to the original purchaser to repair or replace with a comparable reconditioned Directed DIY remote start unit if this Directed DIY remote start unit (hereinafter "Unit"), excluding without limitation, any remote transmitters or associated accessories, proves defective in materials or workmanship under normal use for the life of the vehicle which the Unit is originally installed. During this period, so long as the Unit remained installed in the original vehicle, Directed will at its option, repair or replace this Unit if it is proved defective in workmanship or material PROVIDED the Unit is returned to Directed's warranty department at One Viper Way, Vista, CA 92081, along with \$20 postage and handling fee, a bill of sale or other dated proof of purchase bearing the following information: Date of purchase, name and location of the merchant who sold the Unit, and product description. This warranty does not cover labor costs for the removal or reinstallation of the Unit. This warranty is non-transferable and does not apply to any Unit that has been modified or used in a manner contrary to its intended purpose, and this warranty does not cover damage to any Unit caused by installation or removal of the Unit. This warranty is void if the Unit has been damaged by accident or unreasonable use, neglect, improper service or other causes not arising out of defects in materials or workmanship. Directed makes no warranty against theft of a vehicle or its contents.

THE FOREGOING WARRANTY IS THE EXCLUSIVE PRODUCT WARRANTY, OTHERWISE, ALL WARRANTIES INCLUDING BUT NOT LIMITED TO EXPRESS WARRANTY, IMPLIED WARRANTY, WARRANTY OF MERCHANTABILITY, OR FITNESS FOR A PARTICULAR PURPOSE ARE EXPRESSLY EXCLUDED AND DISCLAIMED TO THE MAXIMUM EXTENT ALLOWED BY LAW, AND DIRECTED NEITHER ASSUMES NOR AUTHORIZES ANY PERSON TO ASSUME FOR IT ANY LIABILITY IN CONNECTION WITH THE SALE OF THE PRODUCT. DIRECTED HAS ABSOLUTELY NO LIABILITY FOR ANY AND ALL ACTS OF THIRD PARTIES INCLUDING ITS AUTHORIZED DEALERS OR INSTALLERS. SOME STATES DO NOT ALLOW THE LIMITATION ON HOW LONG AN IMPLIED WARRANTY LASTS, SO THE ABOVE LIMITATION MAY NOT APPLY TO YOU.

LIMITATION OF DAMAGES AND LIABILITY. CONSUMER'S REMEDY IS LIMITED TO REPAIR OR REPLACEMENT OF THE UNIT, AND IN NO EVENT SHALL DIRECTED'S LIABILITY EXCEED THE PURCHASE PRICE OF THE UNIT. IN ANY EVENT, DIRECTED SHALL NOT BE LIABLE FOR ANY DAMAGES INCLUDING, BUT NOT LIMITED TO, ANY DIRECT, INDIRECT, INCIDENTAL, SPECIAL, PUNITIVE OR CONSEQUENTIAL DAMAGES, LOST PROFITS, LOST SAVINGS, OR, TO THE EXTENT ALLOWED BY APPLICABLE LAW, DAMAGES RESULTING FROM DEATH OR INJURY ARISING OUT OF

OR IN CONNECTION WITH THE INSTALLATION, USE, IMPROPER USE, OR INABILITY TO USE, THE PRODUCT, EVEN IF THE PARTY HAS BEEN ADVISED OF THE POSSIBILITY OF SUCH DAMAGES. SOME STATES DO NOT ALLOW THE EXCLUSION OF LIMITATION OF INCIDENTAL OR CONSEQUENTIAL DAMAGES, SO THE ABOVE LIMITATIONS OR EXCLUSION MAY NOT APPLY TO YOU. THE CONSUMER AGREES AND CONSENTS THAT ALL DISPUTES BETWEEN THE CONSUMER AND DIRECTED SHALL BE RESOLVED IN ACCORDANCE WITH CALIFORNIA LAWS IN SAN DIEGO COUNTY, CALIFORNIA.

IMPORTANT NOTE:

This product warranty is automatically void if its date code or serial number is defaced, missing, or altered.

Make sure you have all of the following information from your dealer:

A clear copy of the sales receipt, showing the following:

- Date of purchase
- Authorized dealer's company name and address
- Item number

table of contents

limited lifetime consumer warranty	i
Install Guide	3
what is included	3
installation tools	3
important information	4
system maintenance	4
fcc/id notice	5
warning! safety first	5
Wiring Quick Reference Guide	7
H1 Harness - 6 pin connector	8
H2 Harness - 8 pin connector	9
H3 harness - 3 pin connector	10
relay heavy gauge wires	10
Installation Overview	11
Step 1, Heavy Gauge Wire Connections	12
Step 2, H1, Main Harness Connections	19
Step 3, H3 Door Lock Connections	23
Step 4, H2 Harness	25
Step 5, Mounting the Receiver/Antenna	31
Step 6, Immobilizer Bypass Modules	33
Step 7, Programming	34
System Diagnostics	47
Remote Start Diagnostics	49
Testing the system	52
Troubleshooting	55
Owner's Guide	58
Transmitter Button Configuration	59
Remote Start Features	60
Alarm and Security Features	66
Convenience Features	71
Glossary of terms	73
Notes	74
quick reference guide:	75

Install Guide

what is included

- Control Module
- 6-Pin Main H1 Harness
- 8-Pin H2 Secondary Harness
- Heavy Gauge Wires
- Antenna and cable
- 5-button remote(s)
- Crash code card
- 3-pin Keyless Entry harness
- Combination Momentary Switch and LED
- Hood Pin Switch
- Hardware Kit

Additional parts may be required (such as relays or bypass).

installation tools

- Digital Multi-Meter
- Drill
- 1/4 Drill Bit (for hood pin switch)
- Screwdrivers (Phillips and Flathead)
- Wire Stripper
- Solder Iron
- Electrical Tape
- Pliers
- Crimping Tool

note: The installation tools listed above may be optional and those required will vary depending on your vehicle.

important information

Congratulations on the purchase of your remote start keyless entry system. This system will allow convenient access to your vehicle with the push of a button, as well as remote start and other optional features. Properly installed, this system will provide years of trouble-free operation.

Please take the time to carefully read this User's Guide in its entirety prior to installing your system.

You can print additional or replacement copies of this manual by accessing the Directed web site at www.autocommand.com.

important! If you are not comfortable working with electronics or unfamiliar with the tools required, please contact your local dealer for advice or ask to have the remote start professionally installed to avoid costly damages. Failure to properly install the remote starter may result in property damage, personal injury, or both.

→ system maintenance

The system requires no specific maintenance. Your transmitter is powered by a miniature 12-volt battery (type 23A) that will last approximately one year under normal use. When the battery begins to weaken, the operating range will be reduced.

→ fcc/id notice

This device complies with Part 15 of FCC rules. Operation is subject to the following conditions: (1) This device may not cause harmful interference, and (2) This device must accept any interference received, including interference that may cause undesirable operation.

Changes or modifications not expressly approved by the party responsible for compliance could void the user's authority to operate this device.

warning! safety first

The following safety warnings must be observed at all times:

When properly installed, this system can start the vehicle via a command signal from the remote control transmitter. Therefore, never operate the system in an area that does not have adequate ventilation. The following precautions are the sole responsibility of the user; however, the following recommendations should be made to all users of this system:

1. Never operate the system in an enclosed or partially enclosed area without ventilation (such as a garage).
2. When parking in an enclosed or partially enclosed area or when having the vehicle serviced, the remote start system must be disabled by placing the system into Valet Mode.
3. It is the user's sole responsibility to properly handle and keep out of reach from children all remote control units to assure that the system does not unintentionally remote start the vehicle.
4. THE USER MUST INSTALL A CARBON MONOXIDE DETECTOR IN OR ABOUT THE LIVING AREA ADJACENT

TO THE VEHICLE. ALL DOORS LEADING FROM ADJACENT LIVING AREAS TO THE ENCLOSED OR PARTIALLY ENCLOSED VEHICLE STORAGE AREA MUST AT ALL TIMES REMAIN CLOSED.

Use of this product in a manner contrary to its intended mode of operation may result in property damage, personal injury, or death. Except when performing the Safety Check outlined in this user's guide, (1) Never remotely start the vehicle with the vehicle in gear, and (2) Never remotely start the vehicle with the keys in the ignition.

After the remote start module has been installed, test the remote start module in accordance with the Safety Check outlined in this installation guide. If the vehicle starts when performing the Neutral Safety Shutdown Circuit test, the remote start unit has not been properly installed. The remote start module must be removed or properly reinstalled so that the vehicle does not start in gear. OPERATION OF THE REMOTE START MODULE IF THE VEHICLE STARTS IN GEAR IS CONTRARY TO ITS INTENDED MODE OF OPERATION. OPERATING THE REMOTE START SYSTEM UNDER THESE CONDITIONS MAY RESULT IN PROPERTY DAMAGE OR PERSONAL INJURY. IMMEDIATELY CEASE THE USE OF THE UNIT AND REPAIR OR DISCONNECT THE INSTALLED REMOTE START MODULE. DIRECTED WILL NOT BE HELD RESPONSIBLE OR PAY FOR INSTALLATION OR REINSTALLATION COSTS.

Wiring Quick Reference Guide

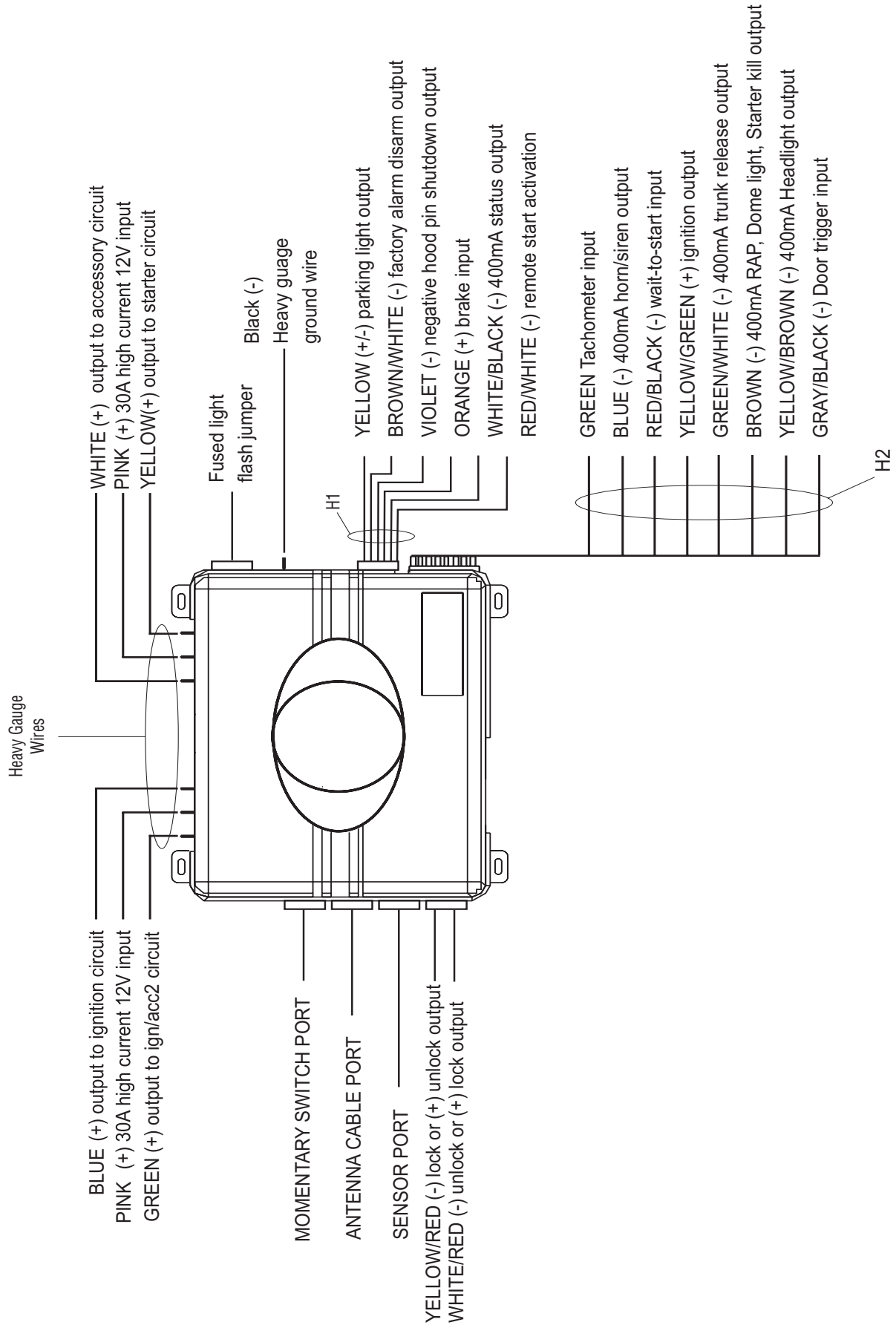

H1 Harness - 6 pin connector

H1/1	YELLOW	(+/-) parking light output
H1/2	BROWN/WHITE	(-) factory disarm output
H1/3	VIOLET	(-) hood pin shutdown input
H1/4	ORANGE	(+) brake switch shutdown input
H1/5	WHITE/BLACK	(-) 400mA status output
H1/6	RED/WHITE	(-) remote start activation input

Pin #	Color	Note
H1/1	Yellow	Selectable positive or negative parking light output
H1/2	Brown/White	Use this wire if the vehicle is equipped with a factory alarm. Connect to disarm wire listed on your sheet.
H1/3	Violet	Connect this wire to supplied hood pin switch
H1/4	Orange	Connect this to wire in vehicle that shows 12 volts when brake is pressed
H1/5	White/Black	Provides a ground during remote start. This wire is normally connected to a bypass module if your vehicle needs one.
H1/6	Red/White	This wire will start the vehicle when it sees two negative pulses. Only used when incorporating into existing alarm or for testing purposes.

H2 Harness - 8 pin connector

H2/1	GREEN	Tachometer input
H2/2	BLUE	(-) 400mA horn/siren output
H2/3	RED/BLACK	(-) wait-to-start input
H2/4	YELLOW/GREEN	(+) ignition output
H2/5	GREEN/WHITE	(-) 400mA trunk release output
H2/6	BROWN	(-) 400mA RAP, Domelight, Starter Kill
H2/7	YELLOW/BROWN	(-) 400mA headlight output
H2/8	GRAY/BLACK	(-) door trigger input

Pin #	Color	Note
H2/1	Green	Use this wire if the vehicle fails to start correctly in voltage mode
H2/2	Blue	Negative output to horn or siren circuit. If your horn is positive, use a relay.
H2/3	Red/Black	Used on diesel engines only. Connects to wait-to-start wire
H2/4	Yellow/Green	Ignition output. Connect this wire to the ignition input of an aftermarket alarm system.
H2/5	Green/White	Trunk release wire. Connect this wire to trunk release wire listed on your vehicle specific printout.
H2/6	Brown	Retained accessory shutdown or factory rearm output. Connect this wire to factory arm wire if equipped or to door trigger wire if your vehicle's accessories stay on after remote start finishes cycle.
H2/7	Yellow/Brown	Headlight output. Connect this wire to headlight wire in car. If headlights are positive, a relay is required.
H2/8	Gray/Black	Door trigger input. This wire connects to the door trigger wire in your car to set off alarm when system is armed and door is opened.

H3 harness - 3 pin connector

H3/1	—	YELLOW/RED	(-) lock/(+) unlock
H3/2	—	EMPTY	
H3/3	—	WHITE/RED	(-) unlock/(+) lock

relay heavy gauge wires

1	—	GREEN	(+) Ign2 or Acc2 output
2	—	PINK	(+) 12 volt input
3	—	BLUE	(+) ignition 1 output
4	—	WHITE	(+) accessory output
5	—	PINK	(+) 12 volt input
6	—	YELLOW	(+) starter output
		BLACK	(-) ground

Installation Overview

Be sure to read this section thoroughly in its entirety before starting the installation. Pay special attention to all warnings to prevent personal injury or damage to your vehicle.

Visit our 24-hour technical web site (www.autocommand.com) to get a vehicle-specific wiring guide prior to starting this installation.

Have your crash code number handy when contacting tech support or visiting the web site. During the installation if you are unable to find answers to your questions on the web site, call 1-800-477-1382 for live technical assistance. Please note that live technical support is available Monday-Friday 6am-6pm PST, and Saturday-Sunday 7am-3:30pm PST.

WARNING!

- Verify that the transmission is set to park and that the parking brake is set before beginning installation.
- On vehicles with air bags or supplemental restraint systems (SRS) you may notice a bright yellow tube with small wires in it marked SRS underneath the steering column near the key cylinder. DO NOT tamper or unplug these for any reason to prevent costly damages to your vehicle or personal injury. Tampering may cause unintended deployment of airbags.
- This system is intended for automatic, fuel-injected vehicles only. Installation in any other vehicle is contrary to its intended use.

Step 1, Heavy Gauge Wire Connections

Ground Wire

The BLACK wire connects to the pin next to the light flash jumper fuse. First strip back a $\frac{3}{4}$ -inch section of the insulation off the BLACK wire and crimp a ring terminal (not provided) to that wire. Locate a clean, paint-free metal surface in the drivers kick panel (do not ground on dash). Using a self-tapping screw, drill the screw with the ring terminal to the kick panel. Once screwed down, pull on the wire to ensure a good connection.

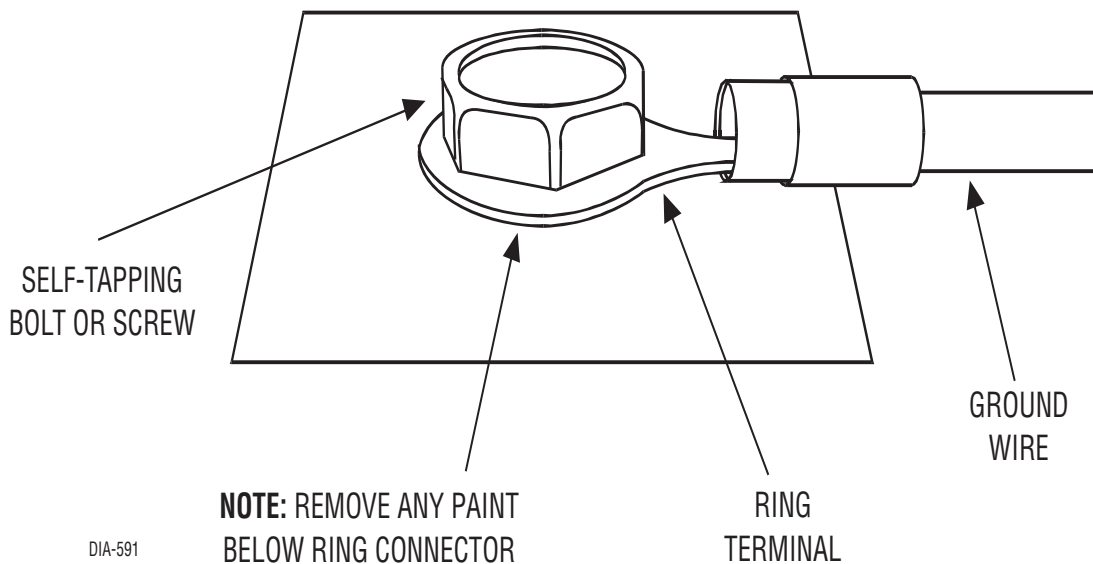

Constant Power and Ignition wires

Almost all your power and ignition wires can be found behind the key cylinder under the lower driver's side dash panel. Using the appropriate hand tools, remove the lower dash panel taking care not to break any parts. If the panel does not come off easily, check for any additional screws you may have missed.

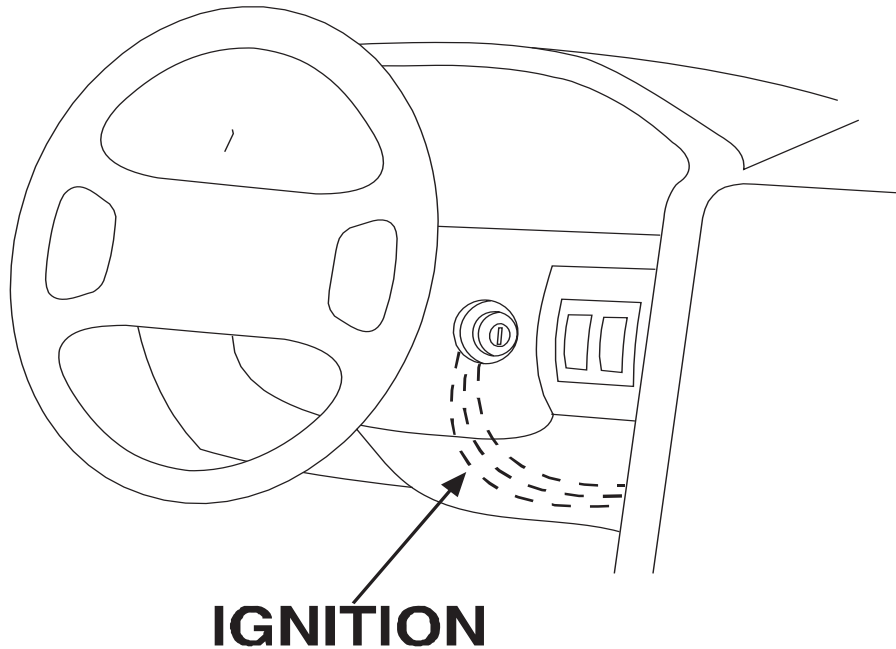

Once the lower dash panel has been removed, locate the ignition harness at the back of the key cylinder. This is usually a group of heavy gauge wires (approximate 14ga.).

Place the black lead of the LED tester to a clean metal surface in the kick panel area and secure it. Probe one of the thicker gauge wires. The ignition wire colors of your specific vehicle can be obtained at www.autocommand.com.

note! More problems are attributed to poor ground connections than any other cause. Take extra care to ensure the ground is a clean metal-to-metal contact and secure.

Testing for Constant Power Wires

WARNING! Before making any connection to constant battery power make sure that the two 30 amp fuses are removed from the fuse holders on the two pink 12 VOLT wires. Failure to do so may cause fire or shorting of sensitive electrical components.

With the key in the off position, test the suspect wire. The constant power wire will read 12V on the multimeter. Once the constant power wire has been identified, solder the two heavy gauge 12 VOLT wires (PINK) from the control module to it and wrap the connection with electrical tape.

note! If the vehicle has more than one constant power wire, utilize two of them. Connect one of the heavy gauge PINK wires to one of the constant power wires and the other heavy gauge PINK wire to the other constant power wire.

Testing for Ignition Wires

With the multimeter lead still connected in the kick panel, locate the suspected ignition wire. It will test differently than constant 12 volts. Place the red lead of the multimeter on the suspected wire. With the key in the off position the multimeter will read 0. Turn the key to the on position and the multimeter will read 12 volts. Now, watching your multimeter, turn the key to the crank position. If the 12 volts stays on, then you have found your ignition wire. If the wire tests correctly, solder the BLUE heavy gauge wire to it and wrap the connection with electrical tape.

If the vehicle requires more than one ignition as per the web site information, follow the same test procedure and solder the GREEN heavy gauge wire to it then wrap the connection with electrical tape. If your vehicle has only one ignition wire, secure the GREEN wire and dress it out of the way.

If your vehicle requires more than two ignitions, an additional relay (not provided) is required. Refer to the diagram below.

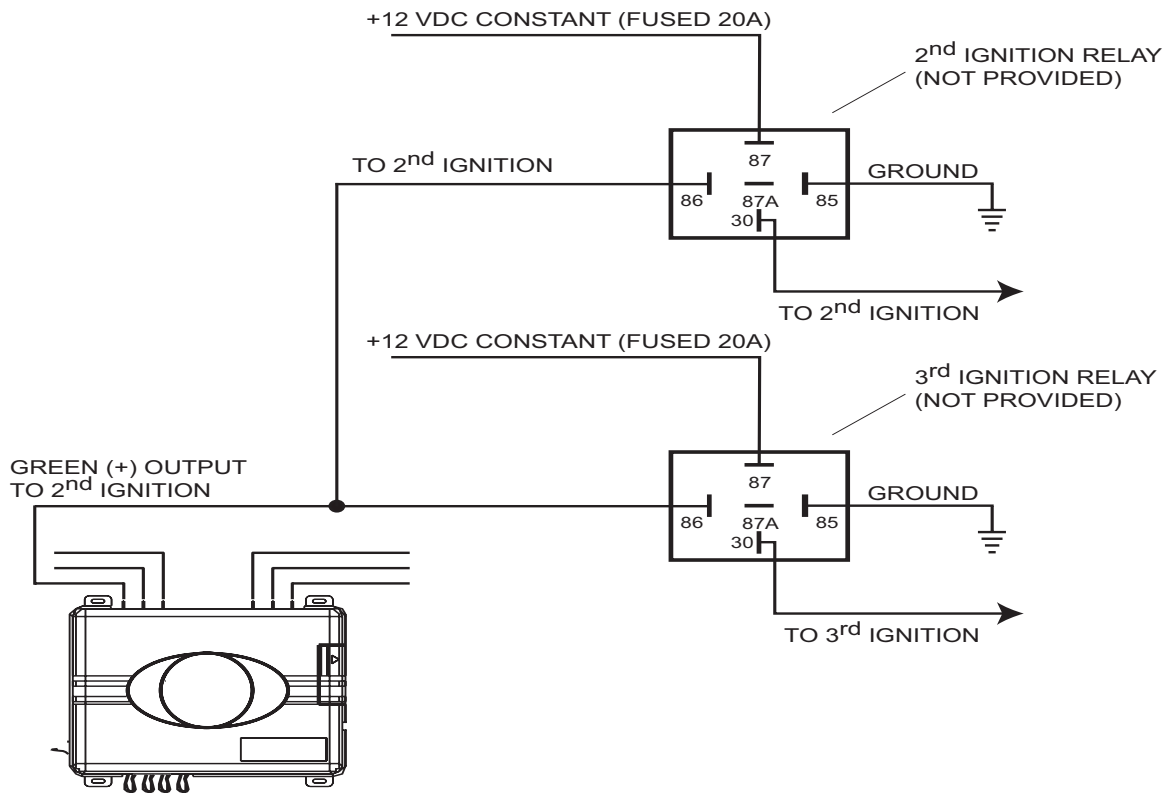

Accessory and Starter wires

The starter and accessory wires will be located in the same harness as the ignition and constant power.

To find the accessory wire leave the multimeter's black lead connected to ground. Take the red lead and probe the wire suspected to be the accessory wire. With the key off, your multimeter should read 0 volts. Turn the key to the on position the multimeter should read 12 volts. Now turn the key to the crank position. If you have the correct accessory wire the multimeter will read 0 volts while the starter is cranking and 12 volts once the key returns to the on position. If the wire tests correctly, strip some insulation off and solder the WHITE heavy gauge wire and wrap it with electrical tape.

If your vehicle requires more than one accessory then the GREEN ign2 wire can be programmed to function as an accessory output.

If the GREEN wire is being used for ign2 an additional relay (not provided) is required for a 2nd accessory. Refer to the diagram below.

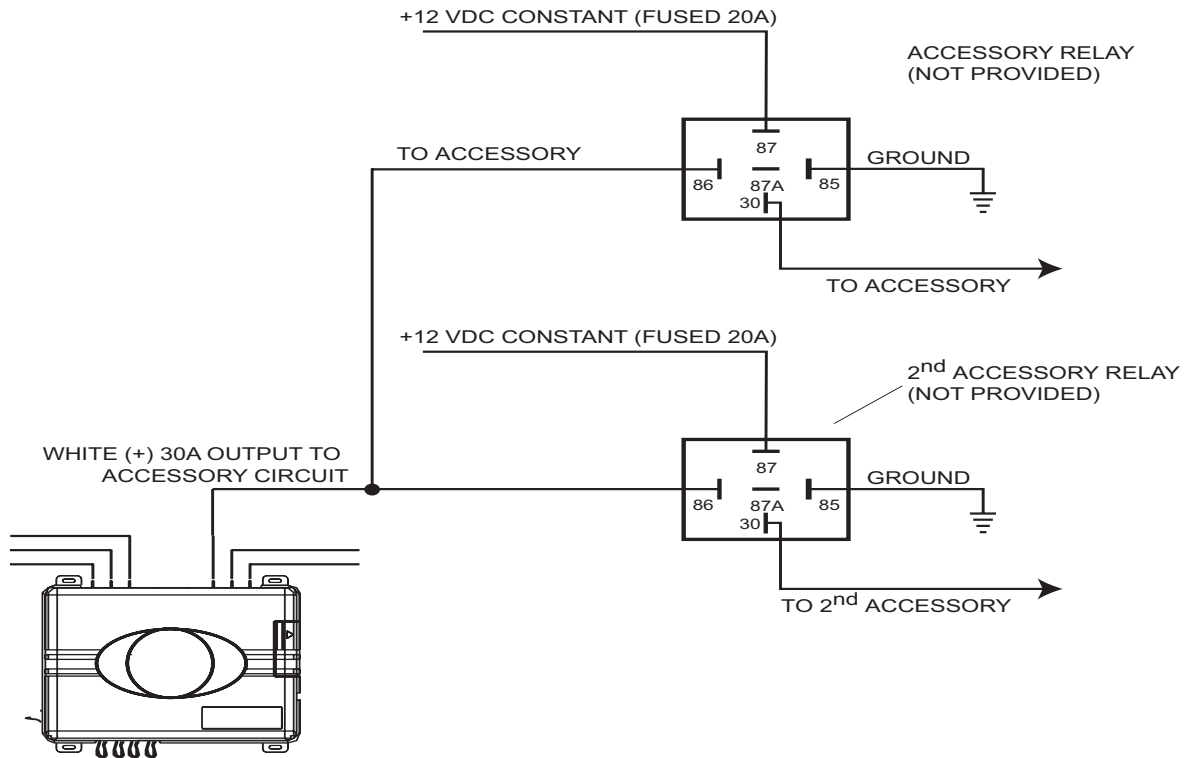

Now that the accessories have been located, find the suspected starter wire according to the web information. Leave the black lead of your tester on ground and place the red lead of your multimeter on this wire. The multimeter should read 0 volts in all key positions except the crank position. In the crank position your multimeter should read 12 volts, and will go to 0 volts when the starter disengages.

Many Nissan and late-model Chrysler vehicles have two starter wires. A relay and/or resistor (not provided) is required to hook up the additional starter wire. Refer to the diagram below.

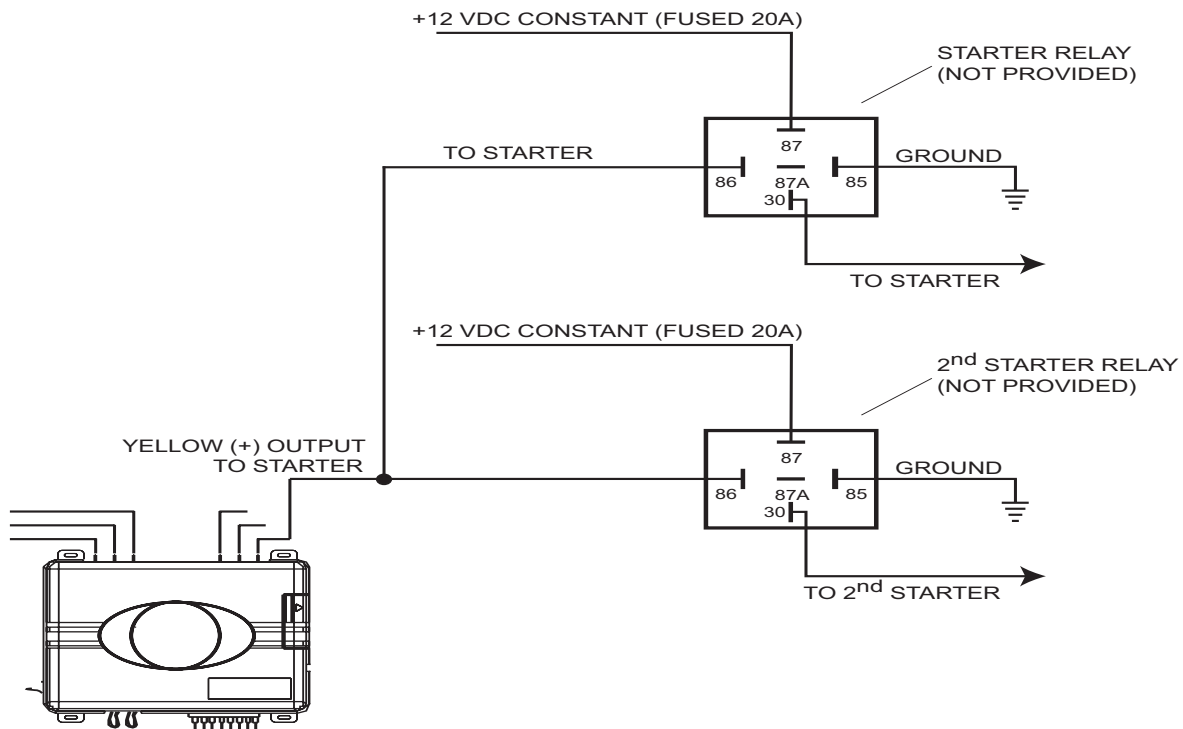

note! Always check the Web site information on your vehicle for warnings regarding the starter wire and check engine lights. Some vehicles will trip a check engine light if the starter wire is cut.

Once you locate the starter wire, cut the wire in half (check the web information before cutting) and try to start the vehicle. If the vehicle does not start, the correct wire has been identified. Reconnect both ends of the starter wire while soldering the thick YELLOW (6) wire of the heavy guage wires to it and wrap the connection with electrical tape.

Step 2, H1, Main Harness Connections

Factory Alarm Disarm

Since many newer vehicles come equipped with a factory alarm it is necessary to disarm it when unlocking the doors or during remote start. Do not mistake a factory alarm with an immobilizer system. They each require different disarm operations.

Locate the factory alarm disarm wire using the web site information. Once the suspect wire is located, place the multi-meter's red lead to a (+)12 volt constant source and secure it. Put the multi-meter in the DC position then probe the suspect wire with the black lead of your meter. While probing the wire, place the key in the driver's door cylinder. Turn it to the unlock position and hold it when testing for the disarm wire. The multimeter should read 12V and will go back to 0V when the key is released.

When the correct wire has been found, solder the BROWN/WHITE wire of the 6-pin harness to the wire that you determined to be the factory alarm disarm wire. After this wire has been connected wrap the connection with electrical tape.

note! On some vehicles the Factory Alarm Disarm wire is connected to a Body Control Module or a Door Module. If you find this configuration, please call Technical Support at 1-800-477-1382.

note! Some vehicles use a + trigger factory alarm system. Use the website to determine if your vehicle has a + trigger. If your vehicle has such a system call 1-800-477-1382 for live technical assistance as special wiring and an additional relay is required.

Parking light flash

There are several different types of parking light circuits. The following description is for a standard positive-triggered parking-light circuit, only. If the web vehicle information suggests a (-) parking light circuit, the fuse jumper (on the side of the module) must be moved to the opposite position.

The default position for this jumper is for a positive parking light circuit.

Using the web information on the vehicle, locate the suspected wire. Connect the black multimeter lead to ground in the kick panel. Probe the suspected wire with the red lead of your meter. With the switch in the off position the multimeter should read 0 volts. While watching the multimeter, turn your headlight switch to the parking light position. The multimeter should read 12 volts.

While testing the suspected wire, run the dash dimmer light control up and down-the voltage should NOT vary. If the voltage does vary then this is the wrong wire. Continue probing to find the correct wire.

Once you have identified the correct wire, solder the small YELLOW wire of the 6-pin harness to it and wrap the connection with electrical tape.

important! Remember this description is for a (+) parking light circuit. A (-) circuit will test differently. Also, if the web information requires using resistors for parking lights, contact Technical Support.

Safety Shutdown Wires

With all ignition wires properly connected, find the appropriate safety shutdown wires. These are the brake wire and hood pin wires.

WARNING! These wires are meant to protect the vehicle and anyone near the vehicle. They **MUST** be connected to prevent damage to the vehicle and possible bodily injury.

First locate the factory brake wire using your multimeter. Find the switch at the top of the metal arm coming off the brake pedal. Use your vehicle specific wiring information to determine the color of this wire. With the black lead of your multimeter still in the kick panel, probe the suspected wire with the red lead of your multimeter. With the brake pedal at rest the multimeter should read 0 volts. While watching the multimeter, depress the brake pedal. The multimeter should read 12 volts. Once you have located the correct brake wire, solder the small **ORANGE** wire in the 6-pin harness to it and wrap the connection with electrical tape.

WARNING! Do not use the vehicle until you confirm the operation of the brake shutdown.

Installing the hood pin switch requires drilling a hole in a metal lip under the hood. Choose a location that will allow the pin switch to be completely depressed when the hood is closed. The pin switch has a spade connector on the bottom for the wire connection.

Crimp your spade connector to the hood pin wire and run the wire into the vehicle's passenger compartment through a factory rubber grommet (at the same time you might want to run Tachometer Input wire and Horn output wire from Optional Harness through the fire wall as you may need to connect them using the following steps).

Using a sharp, pointed object poke a hole into the grommet (being careful not to damage any existing wires in the grommet) and attach the wire to the object with electrical tape. Pull the wire through the grommet taking extra care to keep the wire away from any moving parts or anything that will generate extreme heat.

An alternative to this method would be to find a spot on the firewall with sufficient clearance on both sides and drill an access hole through the firewall. Take note of what is directly on the other side of where you are drilling as to not puncture brake cylinders, computers, etc. Once the wire is run into the vehicle and secured from any moving parts, solder the wire to the VIOLET wire of the 6-pin harness and wrap the connection with electrical tape.

WARNING! This wire MUST be connected. Do not use the vehicle until you confirm the operation of the hood pin shutdown. Improper operation could result injury or death.

Step 3, H3 Door Lock Connections

There are 8 different types of door lock systems (Type A - H). Refer to the vehicle-specific wiring instructions on the web and the chart below to help determine which door lock system your vehicle uses. On some late model GM vehicles a door lock data interface module may be required.

Type A: Three-wire (+) pulse controlling factory lock relays.

Type B: Three-wire (-) pulse controlling factory lock relays.

note! From the factory, your system is set up for Type B (-) door locks. To change your door lock outputs to Type A (+), simply use the wires in the opposite configuration. You will now have (+) door locks.

Type C: Direct-wired reversing-polarity switches. The switches are wired directly to the motors. This type of system has no factory relays. Relays (not included) will be required for this type of door lock system.

Type D: Adding one or more aftermarket actuators. These include slave systems without an actuator in the driver's door, but with factory actuators in all the other doors.

Type E: Electrically-activated vacuum systems.

Type F: One-wire system - cut to lock, ground to unlock.

This is a very rare system found only mainly in early 90's imports

Type G: Positive (+) multiplex. One wire controls lock and unlock using resistor(s).

Type H: Negative (-) multiplex. Same as type G system, but uses (-) pulse instead.

All other door lock systems will require additional relays and/or resistors. A Directed Electronics 451M Doorlock module can be used for these other applications. The 451M also includes diagrams and resistors required for most applications.

Step 4, H2 Harness

Engine Monitoring Explained

During remote start the system will need to know if the engine is running. The module does this by monitoring the voltage of the vehicle's electrical system (or the tachometer-see next section).

Voltage Monitoring

note! If the system has been programmed for Tachometer monitoring previously, it must be reprogrammed to Voltage monitoring.

Vehicle electrical systems usually rest at about 12.6 volts when the engine is not running. This system is programmed to detect the rise in battery voltage that occurs when the charging circuit activates after starting, and keep the engine running if the rise is adequate. It will make up to three start attempts before discontinuing due to an inadequate voltage rise.

Some vehicles have alternators that do not activate immediately or do not increase voltage sufficiently after starting, this system will compensate by delaying the time before reading the battery voltage on the second and third start attempts. This delay will allow most alternators to activate so the remote start will continue to run.

The voltage read times are:

First attempt: 10 seconds

Second attempt: 20 seconds

Third attempt: 50 seconds

After the third start attempt, if the voltage increase is still not adequate to keep the engine running, the Tachometer input option should be used to monitor the engine.

Tachometer Wire

WARNING! In the following procedure DO NOT use a test light. Use of this type of tester can cause grounding of sensitive electrical components causing damage, including damage to the power train control module. A digital multi-meter is required to test for this wire.

Do not wear loose clothing that could get entangled in rotating engine components. Ensure that your hands and arms are well clear of these rotating components when working in the engine compartment. Lastly, ensure that all wires and tools are clear of falling into or entanglement with these rotating components.

Identify the suspected tach wire according to the web information. Next, place the black lead of a MULTI-METER on the negative battery post and secure it. Put the multi-meter in the AC position and connect the probe to the suspect wire with the red lead of the multi-meter. Then start the vehicle with the key. With the engine at idle the multi-meter should read between .50 volts to 6 volts, and should fluctuate when you rev the engine.

Have a second person press the gas pedal to increase the RPMs and watch the meter display. When the RPMs increase the voltage should rise slightly (not all tachometer outputs will rise when engine RPM increases). Once the correct tachometer wire has been identified, turn the vehicle off.

Run the GREEN wire from the 8-pin harness through the firewall into the engine compartment along side the hood pin wire. Use the same procedure as with the hood pin wire and pull the wire through the grommet taking extra care to keep it away from any moving parts or anything that will generate extreme heat. Once the wire is run into the engine compartment, strip a small portion

of insulation off the tachometer wire in the vehicle and solder the green tachometer input wire to it. Then wrap the connection with electrical tape.

note! If using a tach signal, the tach signal **MUST** be learned before using the remote starter.

LEARNING YOUR TACH SIGNAL

If using a tach wire, you must learn the tach signal after completing the installation.

To learn tach signal:

1. Start car with key
2. Wait about 5 seconds for the engine to idle down
3. Press and hold the Momentary switch (about 10 seconds)
4. Tach learned: After a few seconds the LED will flash 2 times and turn on. Continue to hold the switch for 2 - 3 seconds and release.
5. Tach not learned: The LED will not turn on and will flash 3 times when the momentary switch is released. Check the connections and try again.

Following is a brief description of the remainder of the wires in the H2 harness. For specific details on connecting these outputs contact Technical Support at 1-800-477-1382.

Horn/siren wire

The Blue wire provides an output for activating the vehicle horn circuit or an external siren. The output is programmable in Feature Menu 1/9 for the desired use.

important! This is a low current output and that requires an external relay when connected to circuits that draw more than 400mA in current.

Wait-to-start wire

The Red/Black wire is for use with diesel engines that require a short delay for the glow plugs to warm up before cranking the engine. Connect this wire to the wire in the vehicle that sends the signal to turn on the WAIT-TO-START bulb in the dashboard. In most diesels the wire is negative (ground turns on the bulb) and the Red/Black wire can be directly connected. If the vehicle uses a positive wire (12V to turn on the bulb) a relay must be used to change the polarity.

Ignition Output wire

The Yellow/Green wire should be the ONLY the ignition input to an existing aftermarket alarm system. This wire will prevent the host system from sensing that the ignition is on during remote start operation.

Trunk Release wire

The Green/White wire can be used to activate a vehicle trunk release solenoid or to operate optional modules that require a negative input. Whenever the **AUX** button is pressed for a few seconds the system will disarm/unlock and then activate this

output. The output will then remain on until the transmitter button is released.

important! this is a low current output and that requires an external relay when connected to circuits that draw more than 400mA in current.

Retained Accessory, Dome Light or Starter Kill wire

The Brown wire has three optional uses depending on the vehicle application and user preference. The three available operations are programmable in Feature Menu 2/11

- **RAP or Retained Accessory Power:** This option is designed to turn off accessories that remain on after the ignition is turned off. It will pulse 10 seconds after the remote start status output ceases. It will make the vehicle body control module think the door has opened, thus turning the accessories off.
- **Dome Light Supervision:** This option will turn on the dome light for 25 second each time the vehicle is unlocked. It will cease if on when the doors are locked or the ignition in turned on.
- **Start Kill/Anti-grind:** This option activates when the doors are locked to allow for starter kill for the alarm system and also works as an anti-grind when the remote start is active.

important! this is a low current output and that requires an external relay when connected to circuits that draw more than 400mA in current.

Headlight Control wire

The Yellow/Brown wire provides an output for activating the vehicle headlight circuit. It is controlled by both the ignition switch and the transmitter. It is programmable in Feature Menu 1/10 for the type of ignition controlled activation.

important! this is a low current output and that requires an external relay when connected to circuits that draw more than 400mA in current.

Door Trigger wire

The Gray/Black wire will trigger the alarm and is designed to be connected to the door switch that turns on the dome light when the door is opened. It is a negative input circuit only. If your vehicle uses a positive door switch circuit, call for assistance in making the connection.

Step 5, Mounting the Receiver/Antenna

Receiver/antenna position should be discussed with the vehicle owner prior to installation, since the antenna may be visible to the vehicle's operator.

The best location for the receiver/antenna is centered high on either the front or rear windshield. For optimal range, the antenna should be mounted vertically. It can be mounted horizontally in relation to the windshield or under the dashboard away from metal, but range will be diminished. Metallic window tint can also affect range, so this should be a consideration when determining the mounting location.

After determining the best mounting location, follow these steps:

1. Clean the mounting area with a quality glass cleaner or alcohol to remove any dirt or residue.
2. Plug the receiver/antenna cable into the receiver/antenna.
3. Mount the receiver/antenna using the supplied double-sided tape.
4. Route the receiver/antenna cable to the control module and plug it into the four-pin antenna connector.

important! To achieve the best possible range, DO NOT leave the antenna cable bundled under the dash. Always extend the cable full length during installation, regardless of the antenna mounting location.

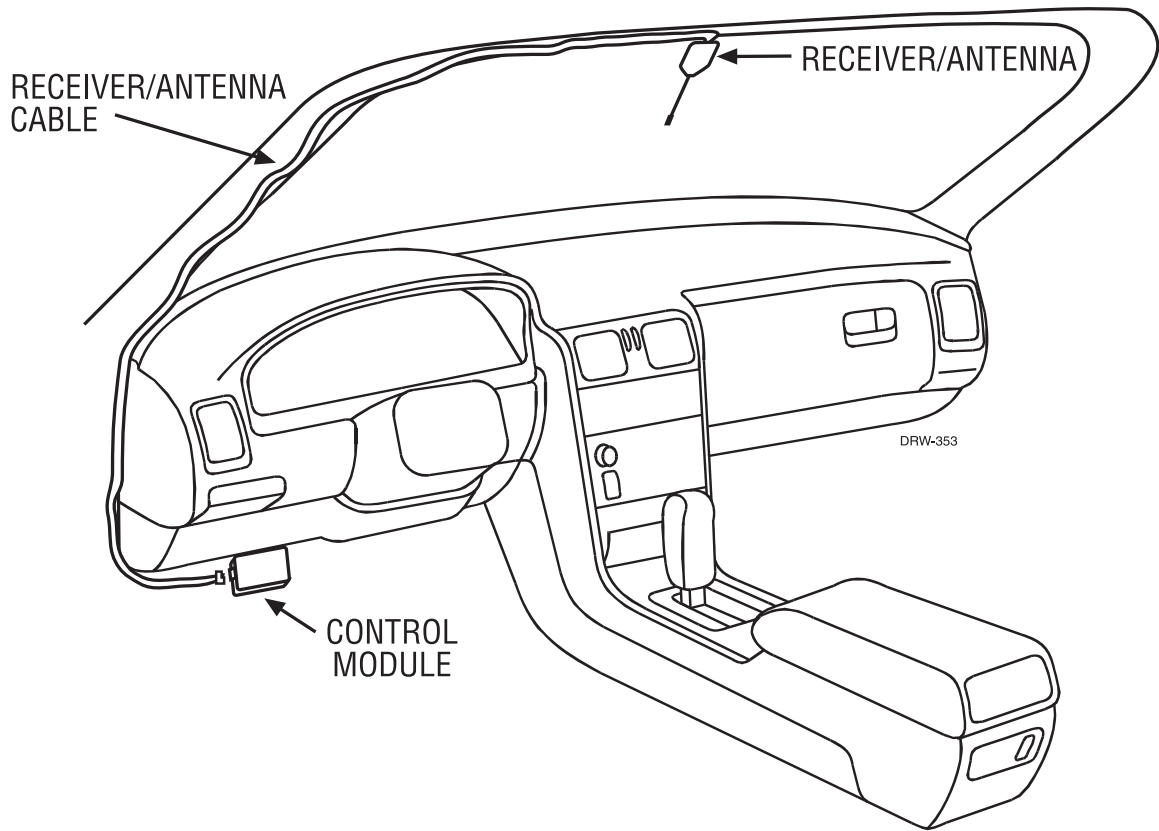

Step 6, Immobilizer Bypass Modules

Most newer vehicles have a factory engine immobilizer system designed to prevent any unauthorized use of the vehicle. These immobilizers will cut off power to the starter and the fuel supply preventing a thief from starting the vehicle.

There are several types of immobilizers, with the most common being the resistance-based passlock/passlock 2 systems found on most newer GM vehicles. This system can be bypassed using the 20402, 29402 or 556L immobilizer bypass modules available at your local authorized retailer or at www.directedstore.com. The majority of transponder-based immobilizer systems can be bypassed using the 20402, 29402 or 556U immobilizer bypass module available at your local authorized retailer.

The WHITE/BLACK wire of the 6-pin harness supplies a 400mA (-) output as soon as the control module begins the remote start process. This wire can be used to activate an immobilizer bypass unit.

note! Any vehicle equipped with a factory immobilizer must use an immobilizer bypass module to remote start. If not used, the vehicle ignition or fuel supply circuits could lock up and require a costly trip to the dealer to reset the computer system.

To determine which bypass module your vehicle requires, use the website Interface Module Look-Up tool at the following website: www.autocommand.com.

Step 7, Programming

Programming transmitters

Your system can learn up to 4 transmitters. The following procedure will show you how to add additional transmitters or replace old ones. Each transmitters can be programmed one button at a time or you can use an auto learn procedure that learns the intended factory configuration. Learning one button at a time is generally only used when using one transmitters to control two different cars. Being able to program functions to different channels on each transmitters prevents multiple cars from responding simultaneously.

1. Turn the ignition ON
2. Press/release the momentary switch the same number of times as the desired transmitter learn Step number, and then Press/HOLD.
3. After Holding the momentary switch for 2 seconds the LED will begin to flash to indicate of the accessed transmitter learn Step.
4. Press the transmitter button that you want to control the function assigned to that transmitter learns Step; the Horn/Siren will emit a long chirp.

note! For transmitter learn Step #1, you must press the "*" button on the transmitter, this will automatically program the transmitter buttons to the default function configuration. See the transmitter button auto learn chart for the assignment functions.

You can learn more than one transmitter function at a time by advancing to another transmitter learn Step.

To do this, first release the momentary SW and then press/release it the same number of times as the difference between the current transmitter learn Step and the desired transmitter learn Step, and then press/HOLD it.

example! To advance from transmitter learn Step 2 to transmitter learn Step 8, release the momentary SW and then press/release it 6 times and HOLD it on the 7th press.

After Holding the Valet Sw for 2 seconds the LED will flash 8 times and repeat. You can now learn a transmitter button to step 8.

There are several ways to exit transmitter Learning, by TimeOut, Ignition or momentary SW Presses.

1. TimeOut: If more than 15 seconds elapse between momentary SW presses or transmitter signals.
2. Ignition: If the Ignition is turned off at any time during transmitter Learning.
3. Momentary SW presses: if you press/release the momentary SW more times than transmitter Learning steps in the menu.

The Horn output will pulse 5 times rapidly and the Led will turn off to indicate exiting feature programming.

Transmitter Button Programming Chart

Step	Function	Button Assignment
1	Auto-Program	ALL buttons to the factory default functions
2	Remote Start	Remote Start/Stop function
3	Trunk Pop	Carfinder & Trunk Pop functions
4	Headlight/Panic/Silent	Headlight, Silent mode & Panic functions
5	Arm & Lock	Arm & Lock function
6	Disarm & Unlock	Disarm & Unlock functions
7	Daily Start	Daily Start function
8	Vacation Mode	Vacation Start function
9	Delete ALL TXs	Removes ALL transmitters from memory

Transmitter Button Auto-Learn



Remote Start/Stop

AUX

CarFinder & Disarm/Trunk Pop



Head Light control, Panic & Silent mode



Arm & Lock



Disarm & Unlock



&



Vacation Mode

AUX

&



Daily Start

Programming System Settings

Many of the features and operations of this system can be changed to suit most of today's vehicle electrical systems. The programming routine and feature menus that follow will allow making the changes required for most vehicle installations.

System programming routine:

Accessing a Menu:

1. Turn the ignition ON and then OFF in less than 5 seconds
2. Within 3 seconds Press/Hold the Momentary Switch
3. After 2 seconds the LED will flash and the Horn/Siren will pulse to indicate the available menus. It will toggle through the outputs until a menu is chosen.
 - a. Menu 1: 1 LED flash and Horn/Siren pulse
 - b. Menu 2: 2 LED flashes and Horn/Siren pulses
4. Release the Momentary Switch after the appropriate output to access that Menu. The LED and Horn/Siren outputs will cease.

Accessing a Feature Location:

1. Press and release (do not hold) the Momentary Switch the same number of times as the feature location to be accessed. See the Feature Chart for locations.
2. After 2 seconds the LED will flash (the number of flashes will match with the feature location) to confirm the feature location. It will flash/pause and repeat until the feature is changed or programming is exited.
3. Press a button on the transmitter to change the feature

option

a. Option 1: Press the transmitter button assigned to the Remote Start function (usually the * button) to set factory default Option 1.

The LED will turn ON and the Horn/Siren will pulse once.

b. Option 2-4: Press the transmitter button assigned to the CarFinder function (usually the AUX button) to set Options 2-4 if available.

The LED will flash and the Horn/Siren will pulse 2-4 times to indicate the option and the LED continue to flash to indicate the option.

Access a different Menu:

To change features in a different menu or return to the beginning of the accessed menu return to Step 2 under Accessing a Menu at any time.

Advance to different feature location:

To advance to a new locations within the same menu press/release the Momentary Switch the same number of times as the difference between the feature locations.

example! to advance from feature location 2 to feature location 8 press/release (do not hold) the Momentary switch 6 times, after 2 seconds the LED will flash 8 times to indicate the newly accessed feature location.

Exiting Feature programming:

The following will cause the system to exit programming and is indicated by 5 short chirps of the Horn/Siren output.

- a. More than 15 seconds lapses between inputs by Momentary switch or transmitter button
- b. The ignition is turned on

Feature Menus

Feature Menu 1 Chart

Feature Location	Feature Name	Option 1 (Default)	Option 2	Option 3	Option 4
1	Engine Monitoring	No Tach	Tach	NA	NA
2	Run Time	15 min	30 min	NA	NA
3	Crank time	Normal	ExtraCrank	Super crank	Mega crank
4	Ign2 Output	Ign 2	ACC 2	NA	NA
5	Wait-to-start	Diesel Input wire	Diesel Timer	NA	NA
6	Activation Input	2 pulse	1 pulse	NA	NA
7	Vacation Temp	0 degrees F	-10 degrees F	-20 degrees F	NA
8	Alarm Disarm	1 second	450 ms	NA	NA
9	Horn Output	Horn/Pulsing	Siren/Constant	NA	NA
10	Headlights	Daytime	Light your way	NA	NA
11	Start Chirp	On	Off	NA	NA
12	NA	NA	NA	NA	NA
13	Reset All Options		Press ANY TRANSMITTER button to reset all features		

Feature Menu 1 Descriptions

1. Engine Monitoring: Defines how the engine is monitored while the Remote Start is active.

1. No Tach: The battery voltage will be used to monitor the engine while Remote Start is active.
2. Tachometer: The tachometer will be used to monitor engine speed while Remote Start is active.

2. Run Time

1. 15 minutes: The Remote Starter will shut down after it has been active for 15 minutes.
2. 30 minutes: The Remote Starter will shut down after it has been active for 30 minutes.

3. Crank Time: Crank Time will be in effect only when Engine Monitoring is "No Tach" and affects the duration of the "Yellow" Starter Output wire.

1. Normal Crank: The Starter output will be 700mS.
2. Extra Crank: The Starter output will be 1 second.
3. Super Crank: The Starter output will be 1.4 seconds.
4. Mega Crank: The Starter output will be 2.1 seconds.

4. Ignition 2 Output: This controls the output type of the high current "Green" ignition 2 output wire.

1. Ignition 2: Output will match the Blue Ignition 1 input/output wire operation during remote start.
2. Accessory 2: Output will match the White Accessory 1 output wires operation.

5. Wait-To-Start: This chooses the method of Starter output delay for Diesel engines.

1. Diesel Input wire: An input on the "Red/Blk" wire will delay the Start output until the input ceases.
2. Diesel Timer: The Starter output will be delayed until the timer expires. The "Red/Blk" wire will be ignored.

6. Activation Input: Selects the number of inputs from the transmitter or the "Red/Wht" activation input wire to activate the Remote Starter.

1. 2 Pulses: Two input pulse will Start and Stop the Remote Starter
2. 1 Pulse: One input pulse will Start and Stop the Remote Starter

7. Vacation Temp: Selects the temperature threshold that will activate the Remote Starter when Vacation Mode has been activated.

1. 0 Degrees F
2. -10 Degrees F
3. -20 Degrees F

8. Alarm Disarm: Selects the output duration of the "Brown/Wht" Factory Alarm Disarm wire.

1. 1 second: The output will be 1 second in duration
2. 450mS: The output will be 450mS in duration

9. Horn Output: Selects the type of output on the "Blue" Horn output wire when the alarm is fully triggered but does not affect the arm/disarm/remote start/programming chirp outputs

1. Horn: The output will be pulsed during full trigger events
 2. Siren: The output will be constant during full trigger events.
10. Headlights: Selects the operation of the "Yellow/Brn" headlight output wire when an ignition input is sensed.
1. Daytime Running: The output will activate 10 seconds after an ignition input is sensed and cease output 1 second after the ignition input ceases.
 2. LightYourWay: The output will activate for 25 seconds immediately after the ignition input ceases.
11. Start Chirps: Selects if the "Blue" Horn/Siren output wire will pulse when activating Remote Starter.
1. On: The Horn output will pulse 1 time at the beginning of Remote Start
 2. Off: The Horn output WILL NOT pulse at the beginning of Remote Start
12. NA: A feature is Not Available for this Location
13. Reset All Options: Pressing a transmitter button when this Feature Location is accessed will "Reset All Options" in both menus to their default setting.

Feature Menu 2 Chart

Feature Location	Feature Name	Option 1 (Default)	Option 2	Option 3
1	Arming Type	Active	Passive	NA
2	Locking Type	Active	Passive	NA
3	Ignition Locking	OFF	Lock w/Ign On / Brake	NA
4	Ignition Unlocking	OFF	Unlock w/Ign OFF	NA
5	Lock Pulses	1	2	NA
6	Unlock Pulses	1	2	NA
7	Lock Duration	Short 0.8 seconds	Long 3.5 seconds	NA
8	Alarm Mode	ON	OFF	NA
9	Auto Rearming	OFF	ON	NA
10	Alarm Chirps	ON	OFF	NA
11	ACC Pulses/Domelight/Starter kill	Accessory Pulse (RAP)	Domelight	Starter Kill/Antigrind Output

Feature Menu 2 Descriptions

1. Arming Type: Selects if the alarm will arm by one or both available methods.

1. Active: The alarm will arm via transmitter only
2. Passive: The alarm will arm via transmitter and Passive Arming criteria.

2. Locking Type: Selects the type of arming operations the door locks will activate with.

1. Active: The doors will lock when armed via transmitter and Auto Re-arming.

2. **Passive:** The doors will lock when armed via transmitter, Passive Arming and Auto Re-arming.
3. **Ignition Locking:** Selects if the door locks will activate after an ignition input is sensed.
 1. **Off:** The Door Lock output will not activate due to an ignition input sense.
 2. **On:** The Door Lock output will activate when the brake input and an ignition input is sensed.
4. **Ignition Unlocking:** Selects if the door locks will activate after the ignition input ceases.
 1. **Off:** The Door Unlock output will not activate when the ignition input ceases.
 2. **On:** The Door Unlock output will activate 100mS after the ignition is turned off.
5. **Lock Pulses:** Selects the number of pulses when locking the doors.
 1. **1 pulse:** The Door Lock output will be one pulse for the programmed duration.
 2. **2 pulses:** The Door Lock output will be 2 pulses for the programmed duration.
6. **Unlock Pulses:** Selects the number of pulses when Unlocking the doors.
 1. **1 pulse:** The Door Unlock output will be a single pulse for the programmed duration.
 2. **2 pulses:** The Door Unlock output will be a double pulse for the programmed duration.

7. Lock Duration: Selects the duration of the pulses when Locking and Unlocking the doors.

1. Short pulse: The Door Lock & Unlock outputs will be 800mS in duration.
2. Long pulse: The Door Lock & Unlock outputs will be a 3.5 seconds in duration.

8. Alarm Mode: Selects if the alarm functions are active or bypassed.

1. On: Alarm functions are operational as described
2. Off: Alarm functions are NOT operational, but convenience features and Remote Starter still operate normally.

9. Auto Re-arming: Selects if the units will automatically Re-arm/lock itself if alarm inputs 1 or 6 are not activated after transmitter disarm/unlock.

1. Off: The unit WILL NOT automatically Arm/Lock the doors after transmitter Disarm/Unlock.
2. On: The unit will automatically Arm/Lock the doors 120 seconds after transmitter Disarm/Unlock if Alarm Inputs 1 or 6 remain idle.

10. Alarm Chirps: Selects if the "Blue" Horn output wire will pulse when Arm/Lock and Disarm/Unlock are activated.

1. On: The Horn output will pulse 1 time for Arm/Lock and 2 times for Disarm/Unlock.
2. Off: The Horn output WILL NOT pulse for Arm/Lock or Disarm/Unlock.

11. Acc pulse/DomeLight/ Starter Kill-Anti-grind: This controls the output of the "Brown" output wire.

1. Accessory Pulse: This output will pulse 10sec after the Remote Starter shuts down, except when the ignition input is active.
2. Dome Light: This output will turn on for 25sec after the Unlock output is completed, and cease if the Ignition is turned on.
3. Starter Kill: This output will activate when the Alarm system is Armed for disabling the vehicle starter circuit and when remote started for Anti-grind.

System Diagnostics

Alarm diagnostics

When arming or disarming the alarm, this system will alert you of alarm triggers or active inputs by changing the Horn/Siren and light flash output. It will then indicate the active input by flashing the LED.

Arming diagnostics:

When arming, if an alarm input is active (door or hood open) the Horn/Siren output and Parking Lights will pulse three times instead of one as an alert.

The LED will then flash/pause and then repeat 5 times to indicate the active input (See alarm input chart)

The active input will be bypassed until it has been inactive for more than 5 seconds but all other alarm inputs will be monitored normally to assure the security of the vehicle

Disarming diagnostics:

When disarming, if the alarm was fully triggered in your absence, the Horn/Siren output and Parking Lights will pulse four times instead of two as an alert.

The LED will then flash/pause and then repeat 5 times to indicate the input that caused the trigger (See alarm input chart).

note! If the alarm was triggered more than once, the diagnostics will only report the last input that fully triggered the alarm. Sensor War-away triggers are not reported in diagnostics.

Alarm Input Chart

LED Flashes	Input Description
1	The 'Gray/Blk' Input wire
2	The 'Orange' Brake Input wire
3	Sensor Input
4	Sensor Input
5	The 'Violet' Hood Input
6	The 'Blue' Ignition Input wire

Remote Start Diagnostics

Remote Start Diagnostics:

Remote Start diagnostics are an important tool that will diagnose the status of the remote start system by letting you know why it remote started, shut down or refused to start as expected.

No Start Diagnostics:

If the system fails to activate Remote Start, Quick stop, Daily Start or Vacation mode as expected the parking lights will flash to indicate the reason. Consult the No Start Diagnostic Chart for the reason.

No Start Diagnostic Chart

Remote Start Feature	LED Flashes	Description
Any	0	Indicates a loss of signal from the transmitter to the system or a loss of power to the main unit.
Daily Start	3	The unit is in the Valet Mode or Battery Voltage is below 11v when attempting to activate this feature.
Vacation Mode	3	The unit is in the Valet Mode, Battery Voltage is below 11v, or the Brake, Hood or Ignition inputs are active
Remote Start	5	The unit is in the Valet Mode, Battery Voltage is below 11v, or the Brake or Hood inputs are active
Quickstop	5	The unit is in the Valet Mode, Battery Voltage is below 11v, or the Brake or Hood inputs are active

Last Start Diagnostics:

The system holds in memory the reason for the most recent remote start activation. This diagnostic report must be recalled using the following operation:

1. Turn the ignition ON and then OFF in less than 5 seconds
2. Within 5 seconds press and release the Monetary Switch
3. After 2 seconds the LED will flash/pause and repeat 5 times to indicate the cause of the most recent remote start activation.
4. Count the LED flashes and consult the Last Start Diagnostic Chart

Last Start Diagnostic Chart

LED Flashes	Description
1	The Remote Starter has not been activated since the main power was connected
2	The Transmitter was used to activate the Remote starter
3	The Activation Input wire was used to activate the Remote starter
4	Low temperature activated the Remote Starter in Vacation Mode
5	Low battery voltage activated the Remote Starter in Vacation Mode
6	No Diagnostics
7	Daily Start activated the Remote Starter

Shut Down Diagnostics:

The system holds in memory the reason for the most recent remote start shut down. This diagnostic report must be recalled using the following operation:



1. Step on the foot brake and hold until Step 4 has begun
2. Turn the ignition ON and then OFF in less than 5 seconds
3. Within 5 seconds press and release the Momentary Switch
4. After 2 seconds the LED will flash/pause and repeat 5 times to indicate the cause of the most recent remote start shut down.
5. Count the LED flashes and consult the Shut Down Diagnostic Chart

Shutdown Diagnostic Chart

LED Flashes	Description
1	The programmed Run Time expired
2	The 'Orange' Brake Input wire was activated
3	The Tachometer Input level fell below 50% of learned value
4	The Transmitter was used shut down remote start
5	The 'Violet' Hood Input wire was activated
6	Battery voltage level fell below required level
7	The alarm was fully triggered
8	The Tachometer Input level was x3 times learned value for >5sec
9	The "Red/Wht" activation Input was used shut down remote start

Testing the system

Once steps 1-7 have been completed, the operation of the system can be tested.

Ensure that the two 30-amp fuses are in the relay harness PINK wire fuse holders. Make sure that the vehicle is in park with the emergency brake on and the hood closed. Press  2 times on the remote to initiate the remote start function. The parking lights should flash to confirm the remote start command has been received, The accessories and ignition should turn on followed by the starter cranking and the vehicle engine running (this may take a moment to initiate). Pressing  2 times again on the remote will shut the engine off. (See Programming System settings section for 1 press remote start operation)

This completes the testing, if all functions do not work correctly check your wiring against the manual and verify all connections. If you still experience problems contact Directed Technical Support at **1-800-477-1382**.

Neutral Safety Test

Some vehicles do not have an electrical neutral safety switch. Instead, a mechanical neutral safety switch that physically interrupts the starter wire is used when the vehicle is in any drive gear. If the remote start is interfaced before this switch, it will provide protection from starting in gear.

However, some vehicles combine the column shift mechanism and the mechanical neutral safety switch into one mechanical part. In these vehicles, it is impossible to interface the remote start system before the neutral safety switch. With this type of vehicle, if the car is left in a drive gear and the remote start system is activated, the vehicle will move and may cause damage to persons or property.

important! This test must be performed to determine if the vehicle will start while in gear. If the vehicle attempts to start during this test you must call Technical Support at 1-800-477-1382 for assistance before using the remote start feature.

Testing the Neutral Safety Switch

note! You must complete the remote start system installation before doing the following test. Ensure that the remote start system is functioning normally. This includes connecting to the brake as a shut-down.

1. Make sure there is adequate clearance to the front and rear of the vehicle because it may move slightly.
2. Make sure the hood is closed and there are no remote start shut-downs active.
3. Set the emergency brake.

4. Turn the key to the "run" position, this will release the shifter.
5. Place the shifter in the drive position.
6. Place your foot directly over the brake pedal, but do not depress it. Be ready to step on the brake if the starter engages.
7. Activate the remote start system.
8. If the starter does not engage, no additional safety interfaces are required.
9. If the starter engages, immediately depress the brake to shut the remote start system down.

IF THE ENGINE ATTEMPTED TO START THE VEHICLE THEN THE TEST
HAS FAILED

CALL TECHNICAL SUPPORT FOR ASSISTANCE AT 1-800-477-1382

warning! If the vehicle fails this test the remote start must be disabled until the proper Safety Interface has been installed that will keep the vehicle from starting while in gear. Failure to do so may result in property damage, injury or death.

Troubleshooting

→ The ignition comes on, but the starter will not crank.

Does it start with the key in the ignition? If so, does the vehicle have an engine immobilizer? Does it start with the brake pedal depressed? (Make sure to disconnect the brake shutdown when performing this test.) If so, it may have a brake/starter interlock. Is the correct starter wire being energized? Check by energizing it yourself with a fused test lead.

→ The starter cranks for 1 or 2-seconds but does not start.

The wrong ignition wire is being energized or the system's ignition and accessory wires have been connected backwards. Also, the vehicle may have two ignition circuits. Try activating the unit with the ignition key in the "run" position. If the vehicle then runs normally, retest your ignition system.

→ The starter continues to crank after the car has started.

Has the tach wire been learned? See the Tach Learning section of this guide. Is the tach wire receiving the correct information? Either the wrong tach wire has been used, or a bad connection exists. Verify that all of the heavy gauge wires are plugged into the correct tabs on the control unit. If they are incorrectly connected, the starter could stay engaged.

→ The climate control system does not work.

Either the wrong accessory wire is being energized or more than one ignition or accessory wire must be energized in order to operate the climate control system.

→ The remote start will not activate.

Check to ensure that the hood is not open and that the brake pedal is not depressed. Check harnesses and connections. Make sure the harnesses are fully plugged into the remote start module. Make sure there are good connections to the vehicle wiring. Check voltage and fuses. Use a meter and check for voltage between the RED wire and the BLACK ground wire. If you have less than battery voltage, check both 30A fuses on the main power wires. Also make sure that the ground wire is going to a good paint-free chassis ground.

→ The remote start will activate but the starter never engages.

1. Check for voltage on the YELLOW starter wire two seconds after the remote start becomes active. If there is voltage present, skip to Step 4. If there is no voltage present, advance to Step 2.
2. Check the 30A fuses.
3. Does the vehicle have an immobilizer? Some Immobilizer systems will not allow the vehicle to crank if active.
4. Check connections. The two PINK heavy gauge input wires should have solid connections. "T-taps", or "scotch locks" are not recommended for any high current heavy gauge wiring. Also, if the vehicle has more than one 12-volt input wire, then connect one PINK wire to each.

→ The vehicle starts, but immediately dies.

Does the vehicle have an immobilizer? The vehicle's immobilizer will cut the fuel and/or spark during unauthorized starting attempts.

→ The vehicle will start and run only for about 10 seconds.

Is the remote start module programmed for voltage sense? If so, try programming the unit to tach mode.

Model 41027, 41027T

➤ *Owner's Guide*

Owner's Guide

Now that the installation is complete and tested, it is time to learn about the many outstanding remote start, security and convenience features that are included in your system.

Remote Start Features

- Remote Start your engine to warm or cool your vehicle before driving
- Quickstop Mode will keep the vehicle interior warm or cool during short trips away from the vehicle
- Daily Start for convenient engine warm up at a specific time the following day
- Vacation Mode maintains battery level when the vehicle is parked for extended periods









Security and Convenience features

- The built in alarm will keep your vehicle secure when parked and remote started
- Keyless entry and starter kill outputs for convenience and security
- Panic Mode feature to call for help if you are threatened while in or near your vehicle
- CarFinder feature helps you find your vehicle in darkened parking lots
- Valet Mode will temporarily defeat the remote start and alarm features but leave the convenience feature available

- Trunk pop output will disarm your alarm and open the trunk as you approach your vehicle
- Headlight output can operate as daytime running lights for safety or light your way securely into your home or office
- Switch Override will disarm the alarm system should you lose your transmitter
- Silent Mode will defeat the chirps for remote start or arm/disarm temporarily when needed
- Auto Re-arm will make sure your vehicle is locked at all times if mistakenly unlocked

Transmitter Button Configuration

Using the Auto Learn operation for programming transmitters to this system will result in the following transmitter icon operations.

-  controls the Remote Start/Stop functions
-  controls the CarFinder and Trunk Pop functions
-  controls the Headlight activation, Panic & Silent mode functions
-  controls the Alarm Arm and Locking functions
-  controls the Alarm Disarm and Unlocking functions
-  &  activates the Vacation Mode feature
-  &  activates the Daily Start feature

OPERATING YOUR SYSTEMS FEATURES

The Remote Start, Alarm and Convenience features described in this section follow the transmitter button assignments using the Auto-Learn step when programming a transmitter.

Remote Start Features

Remote Start allows you to remotely start and run your vehicle for a programmed period of time. This makes it possible to warm up the engine, as well as adjust the interior temperature of the vehicle with the climate control system. If interior heating or cooling is desired, the climate controls must be preset, and the fan blower must be set to the desired level prior to remote starting the vehicle.

Remote Start operation is completely disabled by placing the system into the Valet Mode. The Remote Start, Quick Stop, Daily Start and Vacation Mode features will not operate when in the Valet Mode. See the Alarm Features section for information on entering Valet Mode.

Remote Start the vehicle:

- Press the * button of the transmitter twice.
- The parking lights will flash once and the Horn/Siren will chirp once to confirm that the vehicle will attempt to start.
- The engine will start a few seconds after the parking lights flash.
- Once started, the lights will flash and it will run for the programmed period of time

note! If the lights flash more than once and the engine does not start, refer to the No Start Diagnostics for the cause.

important! Never remote start your vehicle when the keys are in the ignition, except when activating Quick Stop Mode, and never start the vehicle if it is not in PARK and the Parking brake is not set.

important! It is unsafe to operate a vehicle's motor in a garage or other closed off area. Breathing the exhaust from the vehicle is hazardous to your health. Never activate the remote start in an enclosed space.

When you are ready to drive the vehicle:

- Insert the ignition key and turn it to the ON (not the START) position.
- Press the brake pedal, the remote start will shut down and the engine will continue to run

note! If the brake pedal is pressed before the key is in the ON position, the engine will shut down.

To shut down remote start:

The remote start can be shut down in several ways for convenience by the user or for safety by the shut down inputs.

User remote start shut downs:

- The transmitter * button is pressed twice.
- Pulse the activation input wire twice

- The user steps on the brake as they begin to drive the vehicle

Safety shut down inputs:

While the vehicle is running during remote start operation, the system will monitor the vehicle and will automatically shut down the engine if the system receives any of the following shutdowns

- The brake pedal is pressed.
- The hood is opened.
- The programmed run time has elapsed.
- The alarm is triggered
- Low battery voltage
- High or low tachometer signal

Quick Stop Mode

The Quick Stop feature allows the vehicle to remain running after the key has been removed from the ignition. This feature is useful for occasions when you wish to exit and lock the vehicle for short periods of time, but would like to leave the motor running and the climate controls on.

To activate Quick Stop:

- With the ignition On and the engine running, do one of the following:
 - Press and release on the transmitter  button twice.
 - Press and release the Momentary Switch 4 times quickly
 - Pulse the activation input wire twice

- The Horn/Siren will chirp once and the lights will begin flashing to indicate Quick Stop Mode is active.
- Turn the ignition key to the OFF position. (The engine will stay running.)
- Exit the vehicle and arm/lock the doors.
- The engine will run for the programmed run time or until a shut down input is activated.

note! Quick Stop mode will not activate if the brake pedal is depressed.

Daily Start

The Daily Start feature will automatically start the engine 24 hours after it has been activated. This is convenient if you leave your house for work at the same time everyday. Simply activate as described 24 hours before you wish for the engine to start.

To activate Daily Start:

- Press and hold the **AUX** &  buttons on your transmitter for more than 3 seconds
- The parking lights will flash 4 times and the Horn/siren will chirp once to confirm Daily Start is activated.
- Your vehicles engine will Remote Start in 24 hours.

note! The alarm and remote start functions will be fully operational while Daily Start is active.

important! When Daily Start is active **ONLY** park you car in a well ventilated areas.



To de-activate Daily Start:

- Press and hold the **AUX** &  buttons on your transmitter for more than 3 seconds
- Activate Vacation Mode
- The parking lights will flash 4 times to confirm Daily Start has been de-activated. (The Horn/siren will not chirp)

Vacation Mode

Vacation mode is a valuable feature designed to maintain normal operating conditions when the vehicle is parked for extended periods. Vacation mode will monitor and automatically start the engine any time the system detects extremely low battery voltage or temperatures (See Programming Section for available low temperature settings).

To activate Vacation Mode:

- Press and hold the  &  buttons on your transmitter for more than 3 seconds
- The parking lights will flash 5 times and the Horn/Siren will chirp once to confirm Vacation Mode is activated.
- Your vehicles battery level and interior temperature will be monitored and the engine will automatically start up to 8 times.
- Temperature: the system will check the interior temperature and start if required every three hours
- Battery level: the system will start the engine immediately when the battery level drops below 11.5 volts.

note! The alarm functions will be fully operational while Vacation Mode is activated.

important! When Vacation mode is activated ONLY park you car in a well ventilated areas.

To de-activate Vacation Mode:

- Press and hold the * &  buttons on your transmitter for more than 3 seconds
- Activate Daily Start
- Activate the Ignition, Hood or Brake inputs at any time
- The parking lights will flash 5 times to confirm Vacation mode has been de-activated. (The Horn/siren will not chirp)

Alarm and Security Features

Transmitter Arming of the Alarm

You can arm the system by pressing the  button of your transmitter for one second. When the system arms, the Horn/Siren output will chirp once and the parking lights will flash once.

If the power door locks are controlled by the system, the doors will also lock. While the system is armed, the status LED will flash once per second, indicating that the system is actively protecting your vehicle.

If the Horn/Siren pulses and the lights flash 3 times, refer to the Diagnostics Section. This indicates an alarm input is active at the time of arming and should be checked. The LED will flash in groups to indicate the active input.

Passive Arming of the Alarm

This system can be programmed to arm itself automatically (called passive arming). If the system is programmed for passive arming, it will automatically arm 30 seconds after the ignition is turned off and the system detects that you have left the vehicle by opening and closing a door.

Whenever the system is in its 30-second passive arming countdown, the status LED will flash rapidly. At the 30-second point, the Horn/Siren will chirp and the parking lights will flash to indicate that the system is armed.

note! If the door, brake or hood inputs are activated during the 30 second countdown the timer will stop and reset, it will re-start once the input becomes inactive. Active sensor inputs will not stop the countdown.

Auto-rearming feature

Auto-rearming is designed to protect the vehicle in case of unintended disarming of the alarm.

It will automatically re-arm the alarm and lock the doors 120 seconds after any transmitter disarm occurs.

To stop Auto-rearm simply open a door or turn the ignition on before the 120 seconds expires.

Alarm Input Operations

When armed the alarm has 6 inputs that will cause a full alarm trigger output. Refer to the Alarm Diagnostic section for additional detail.

- The Door, Hood, Ignition and Brake inputs will cause an immediate full trigger output when activated.
- The Sensor inputs can cause two types of outputs; Warn-away and Full Trigger.

note! An optional two stage sensor is required for the Sensor outputs to activate. Call Technical Support for more information on compatible sensors.

Alarm Trigger Outputs

- Warn-away output: this output consists of 5 chirps of the Horn/Siren output and 3 flashes of the parking lights.
- Full Trigger output: this output consists of flashing the Parking lights and the Horn/Siren output for 30 seconds followed by a 5 second pause to monitor the alarm inputs. If an alarm input is still active the output will repeat.

Transmitter Disarming the Alarm

To disarm the security system, press the  button of the transmitter. When the system disarms, the Horn/Siren output will chirp twice and the parking lights will flash twice.

If the power door locks are controlled by the system, the doors will also unlock. The LED will turn off and the vehicle can be entered.

If the Horn/Siren pulses and the lights flash 4 times, refer to the Diagnostics Section. This indicates that the alarm was fully triggered in your absence. The LED will flash in groups to indicate the input that caused the trigger.

Momentary Switch Disarming the Alarm

If your transmitter is lost or will not disarm the alarm, you can manually override it using your ignition key and the Momentary Switch.

To override the Alarm using the Momentary Switch

- Enter the vehicle, the alarm will sound
- Insert the key into the ignition and turn it to the On position
- Immediately press and release the Momentary Switch 2 times
- After 2 seconds the alarm will disarm as though the transmitter had been used.

Panic Mode

This system includes a Panic Mode operation that will alert other around you if you are threatened while in or near your vehicle. Due to state laws the Panic Mode is defeated when the ignition is on.

To active Panic Mode:

- Press and hold the  button on the transmitter for 6 seconds
- The Horn/Siren output and light flash will activate for 45 seconds

To de-active Panic Mode:

- Press and release the  button on the transmitter
- Arm or Disarm the alarm system

Zone Bypass Feature

The Zone Bypass feature temporarily bypasses alarm inputs that trigger excessively when the system is armed while monitoring the other inputs for triggers. This keeps constant triggers due to environmental reasons from annoying the neighbors.

Protected entry bypass:

If the door, hood, brake or ignition inputs become activated through 3 consecutive 30 second full trigger durations, it will be bypassed until it has become inactive for more than 5 seconds.

Sensor bypass:

If one of the sensor inputs is triggered 3 times within 1 hour, a bypass timer will begin and that input will be bypassed for 1 hour. If a trigger occurs on that input while the bypass timer is active, the bypass timer will reset.

You can Disarm and then Rearm the alarm to defeat the sensor bypass at any time.

Valet Mode

Valet Mode will defeat the alarm trigger and remote start operations while leaving all other security and convenience features available such as Panic, Trunk Pop, Door Lock/Unlock and Carfinder.

To enter Valet Mode:

- Press and hold the Momentary Switch
- Turn the ignition On and Off in less than 5 seconds
- Continue to hold the Momentary Switch
- After 2 seconds the LED will turn on solid, Valet Mode is entered

note! The LED will stay on only when the ignition is off. After the ignition has been off for 24 hours the LED will turn off until the ignition is cycled on/off.

To exit Valet Mode:

- Press and hold the Momentary Switch
- Turn the ignition On and Off in less than 5 seconds
- Continue to hold the Momentary Switch
- After 2 seconds the LED will turn off, Valet Mode is exited

Convenience Features

Carfinder Feature

This feature allows you easily locate you vehicle in large and darkened parking areas by pulsing the lights and Horn/Siren outputs.

To activate Carfinder:

- Press and release the **AUX** button on the transmitter
- The headlight output, parking light output and the Horn/siren output will pulse once

Silent Mode

Silent Mode allows you to temporarily delete the Horn/Siren output when arming, disarming or activating remote start.

To use Silent Mode:

- Press and release quickly the  button on the transmitter
- After 1 second press the transmitter button of the feature to be activated without a Horn/Siren output

note! 10 seconds after step 1 the Horn/Siren output will be re-activated. If silent Mode is your preferred normal operation the Horn/Siren output can be programmed off in the feature menus. Then using Silent Mode will temporarily turn on the Horn/Siren output.

Headlight Control

This feature allows you to toggle the headlight output on and off anytime the ignition is off.

To activate the Headlights:

- Press and hold for 3 seconds the  button on the transmitter and then release it.
- The headlight output toggle on/off according to its present state

note! The headlight output timer is 25 seconds and is controlled by the ignition input according to the programmed setting.

Trunk Pop

This feature allows you disarm the alarm, unlock the doors and pop your trunk open with one press of a button

To activate the Trunk Pop:

- Press and hold for 3 seconds the  button on the transmitter
- The alarm will disarm, unlock the doors and the auxiliary output will pulse

Note: The auxiliary output will stay active until the transmitter  button is released.

Glossary of terms

Control Module: The “brain” of your system. Usually hidden under the dash area of the vehicle. It houses the microprocessor that monitors your vehicle and controls all system functions.

FAD: Factory Alarm Disarm. Some vehicles with a factory alarm require the alarm to be disarmed before remote starting.



RAP: Retained Accessory Power. After the vehicle is started and then shut down, the power to the radio remains on (retained) until a vehicle door is opened.

Transmitter: A hand-held, remote control which operates the various functions of your system.



Cut along dotted line and fold for a quick and easy reference to keep in your purse or wallet.

QUICK REFERENCE GUIDE:

Alarm Operation

- To Arm and Lock: Press the  button for one second. The doors will lock and the parking lights and Horn/Siren will pulse once.
- To Disarm and Unlock: Press the  button for one second. The doors will unlock and the parking lights and Horn/Siren will pulse twice.



Security and Convenience Features

- Activate Panic Mode: Press and hold the  button for 6 seconds
- Activate CarFinder: Press/release quickly the **AUX** button
- Activate Headlights: Press and hold for 3 seconds and then release the  button
- Open the Trunk: Press and hold the **AUX** button for 3 seconds

Remote Start the engine

- To Start: Press the  button twice. The engine will start and the parking lights will flash to confirm start.
- To Stop: Perform the same steps as above to shut down remote start.



Quick stop Mode

- To activate: Press the  button twice with ignition on and the engine running or press/release the Momentary Switch 4 times
- To de-activate: Press the  button twice or step on the brake

Daily Start

- To activate: Press the  and **AUX** buttons for three seconds. The lights will flash 4 times and the Horn/Siren will chirp once to confirm.
- To de-activate: Perform the same step to exit, the parking lights will flash 4 times, the Horn/siren will not pulse

Vacation mode

- To activate: Press the  and  buttons for three seconds. The lights will flash 5 times and the Horn/Siren will chirp once to confirm.
- To de-activate: Perform the same step to exit, the parking lights will flash 5 times, the Horn/siren will not pulse

The company behind this system is Directed Electronics

Since its inception, Directed Electronics has had one purpose, to provide consumers with the finest vehicle security and car stereo products and accessories available. The recipient of nearly 100 patents and Innovations Awards in the field of advanced electronic technology, DIRECTED is ISO 9001 registered.

Quality Directed Electronics products are sold and serviced throughout North America and around the world.

Call (800) 274-0200 for more information about our products and services.



Directed Electronics is an ISO 9001 registered company.

Directed Electronics is committed to delivering world class quality products and services that excite and delight our customers.

driven to excel
Directed[®]
E L E C T R O N I C S

Directed Electronics
Vista, CA 92081
www.directed.com

© 2006 Directed Electronics—All rights reserved
N41027 06-06